



**Business Improvement District Council:  
Public Right-of-Way  
Enhancement Program**

**This Program will operate within the following Business Improvement Districts: Adams Ave, City Heights, Downtown Partnership, College Area, East Village, El Cajon Blvd. Hillcrest, La Jolla, Little Italy, Mission Hills, North Park, Ocean Beach, Old Town, Pacific Beach, and San Ysidro**

Updated 3-19-13

**ADAMS AVENUE**

Adams Ave. Business Assn  
 Scott Kessler  
 4649 Hawley Blvd.  
 San Diego, CA 92116  
 619.282.7329 Office  
 619.282.8751 Fax  
<http://adamsavenuebusiness.com>

**CITY HEIGHTS**

City Heights Business Assn  
 Enrique Gandarilla, Exec. Dir.  
 4305 University Ave., #540  
 San Diego, CA 92105  
 619.906.4443 Office  
 619.795.4985 Fax  
[Enrique@cityheightsba.org](mailto:Enrique@cityheightsba.org)  
[www.cityheightsba.org](http://www.cityheightsba.org)

**COLLEGE AREA**

College Area EDC  
 Jennifer Finnegan, Exec. Dir.  
Mailing Address:  
 PO Box 151176  
 San Diego, CA 92175-1176  
Office:  
 4704 College Ave  
 San Diego, CA 92115  
 619.582.1093 Office  
 619.582.1293 Fax  
[executivedirector@collegeareabid.com](mailto:executivedirector@collegeareabid.com)  
[www.collegeareabid.com](http://www.collegeareabid.com)

**DIAMOND**

NPM- vacant

**DOWNTOWN**

Downtown San Diego Ptrshp  
 Bahija Hamraz,  
 401 "B" Street, Suite 100  
 San Diego, CA 92101  
 619.234.0201x109 Office  
 619.234.3444 Fax  
[bhamraz@improvedtsd.com](mailto:bhamraz@improvedtsd.com)  
[www.dtsd.org](http://www.dtsd.org)

**EAST VILLAGE**

East Village Association  
 Lisa Lem- Exec. Director  
 1202 Market Street  
 San Diego CA 92101  
 619.992-7525 Office  
[ed@eastvillagesandiego.com](mailto:ed@eastvillagesandiego.com)  
[www.eastvillagesandiego.com](http://www.eastvillagesandiego.com)

**EL CAJON BOULEVARD**

El Cajon Blvd. BIAS  
 Veronica Kleinhenn, Bus. Mgr  
 3727 El Cajon Blvd  
 San Diego, CA 92105  
 619.283.2306

619.283.0050 Fax  
[info@theboulevard.org](mailto:info@theboulevard.org)  
[www.theboulevard.org](http://www.theboulevard.org)

**GASLAMP QUARTER**

Gaslamp Quarter Association  
 Jimmy Parker, Exec. Dir.  
 614 Fifth Avenue, Suite E  
 San Diego, CA 92101  
 619.233.5227 Office  
 619.233.4693 Fax  
[Jimmy@gaslamp.org](mailto:Jimmy@gaslamp.org)  
[www.gaslamp.org](http://www.gaslamp.org)

**HILLCREST**

Hillcrest Association  
 Ben Nicholls, Exec. Dir.  
 3737 5<sup>th</sup> Ave. Suite 201  
 619.299.3330 Office  
 619.299.4230 Fax  
[info@hillcrestbia.org](mailto:info@hillcrestbia.org)  
[www.hillcrestassociation.com](http://www.hillcrestassociation.com)

**LA JOLLA**

La Jolla Village Merchants  
 Association  
 Sheila Fortune Exec. Dir.  
Mailing Address:  
 PO Box 9047  
 La Jolla, CA 92038  
Office:  
 7734 Herschel Ave., Suite G  
 La Jolla, CA 92037  
 858.454.5718 Office  
 858.454.5038 Fax  
[sfortune@lajollabythesea.com](mailto:sfortune@lajollabythesea.com)  
[www.lajollabythesea.com](http://www.lajollabythesea.com)

**LITTLE ITALY**

Little Italy Association  
 Under Management of:  
 New City America  
 Attn: Chris Gomez  
 2210 Columbia Street  
 San Diego, CA 92101  
 619.233.3898 Office  
 619.233.4866 Fax  
[mail@littleitalysd.com](mailto:mail@littleitalysd.com)  
[www.littleitalysd.com](http://www.littleitalysd.com)

**MISSION HILLS**

Mission Hills BID  
 Gerrie Trussell, Exec. Dir.  
 PO Box 82172  
 San Diego, CA 92138  
 619.920.2121 Office  
 619.291.9383 Fax  
[missionhillsbid@gmail.com](mailto:missionhillsbid@gmail.com)

**NORTH PARK**

North Park Main Street  
 Angela Landsberg, Exec. Dir.  
 3076 University Ave  
 San Diego, CA 92104  
 619.294.2501 Office  
 619.294.2502 Fax  
[angela@northparkmainstreet.com](mailto:angela@northparkmainstreet.com)  
[npbid@northparkmainstreet.com](mailto:npbid@northparkmainstreet.com)  
[www.northparkmainstreet.com](http://www.northparkmainstreet.com)

**OCEAN BEACH**

Ocean Beach Main St. Assn  
 Denise (Denny) Knox, Exec. Dir.  
 1868 Bacon Street, Ste. "A"  
 San Diego, CA 92107  
 619.224.4906 Office  
 619.224.4976 Fax  
[info@oceanbeachsandiego.com](mailto:info@oceanbeachsandiego.com)  
[www.OceanBeachSanDiego.com](http://www.OceanBeachSanDiego.com)

**OLD TOWN**

Old Town SD Chamber of  
 Commerce  
 Richard Stegner, Exec. Dir.  
Mailing Address:  
 PO Box 82686  
 San Diego, CA 92138  
Office:  
 2415 San Diego Ave.  
 San Diego, CA 92110  
 619.291.4903 Office  
 619.291.9383 Fax  
[otsd@aol.com](mailto:otsd@aol.com)  
[www.oldtownsandiego.org](http://www.oldtownsandiego.org)

**PACIFIC BEACH**

Discover Pacific Beach  
 Sara Berns, Exec. Dir.  
 1503 Garnet Ave  
 San Diego, CA 92109  
 858.273.3303 Office  
 858.581.6748 Fax  
[sara@pacificbeach.org](mailto:sara@pacificbeach.org)  
[www.pacificbeach.org](http://www.pacificbeach.org)

**SAN YSIDRO**

San Ysidro Business Assn  
 Jason MB. Wells, Exec. Dir.  
 663 E. San Ysidro Blvd  
 San Ysidro, CA 92173  
 619.428.5200 Office  
 619.428.5400 Fax  
[aripa@sanysidrobiz.com](mailto:aripa@sanysidrobiz.com)  
[www.sanysidrobiz.com](http://www.sanysidrobiz.com)

[www.bidcouncil.org](http://www.bidcouncil.org) for current  
 information. Current as of  
 8.2012

**Business Improvement District Council:**

**Public Right-of-Way Enhancement Program**

This Program will operate within the following Business Improvement Districts: Adams Ave, City Heights, Downtown Partnership, College Area, East Village, El Cajon Blvd. Hillcrest, La Jolla, Little Italy, Mission Hills, North Park, Ocean Beach, Old Town, Pacific Beach, and San Ysidro

Table of Contents

	Page
I. Purpose and Intent of the Program	3
II. Abbreviations and Definitions	3
III. General Requirements	5
IV. Freestanding Sign Standards	9
V. Outdoor Display Standards	12
VI. Outdoor Dining Standards	16
VII. Permit Conditions	18
VIII. Enforcement and Due Process	19
IX. Application Form	

Business Improvement District Council:  
**Public Right-of-Way Enhancement Program**

**This program will operate within the following Business Improvement Districts: Adams Ave, City Heights, Downtown Partnership, College Area, East Village, El Cajon Blvd. Hillcrest, La Jolla, Little Italy, Mission Hills, North Park, Ocean Beach, Old Town, Pacific Beach, and San Ysidro.**

**I. PURPOSE AND INTENT OF THE PROGRAM**

The purpose of the Public Right of Way Enhancement Program (PROW) is to optimize the growth and income of retail businesses and restaurants by allowing and encouraging the use of portions of the public right-of-way between the curb and the adjacent property line. The Program will promote an environment that encourages pedestrian traffic. It will also encourage beautification of the streetscape with landscaping placed in planter boxes and pots.

The program's three areas of endeavor are freestanding signs, outdoor display areas, and outdoor dining areas. A business owner will be allowed to locate these items in the public right-of-way provided he or she obtains approval of the Non-Profit Management Corporation having jurisdiction and then conforms to the requirements of this program.

It is not the intent of the PROW Enhancement Program to set aside existing or future City, State, or Federal regulations regarding public health, safety and accessibility in the public right-of-way.

**Note: Only those businesses fronting on the public right-of-way and located on the first floor may participate in the program.**

**II. ABBREVIATIONS AND DEFINITIONS**

**ABBREVIATIONS**

BID- Business Improvement District  
NPM- Non-profit Management Corporation.  
NCCD- City of San Diego Neighborhood Code Compliance Department.  
PL- Property line  
PROW- Public Right-of-Way  
ROW- Right-of-way

**DEFINITIONS:**

**Clear Area:** the area adjacent to street furniture as required for a clear path of travel or for maintenance or access as defined in the General Regulations of this Project.

Clear Path of Travel: a route for use by pedestrian and wheelchair users that provides free and unobstructed access to and egress from a building, area, street furniture or location.

Display Item: a product being displayed for public view. See also "Outdoor Display Item".

Display Type: A category of items (such as clothing, artwork, craftwork, books, food, or furniture).

Enhancements: For the purposes of this regulation, "enhancements" shall mean freestanding signs, outdoor display items, and outdoor dining furniture (including chairs, tables, umbrellas, planter pots or boxes, sculptural works, and temporary railings) located in the PROW.

Freestanding sign: A temporary sign that rests on the ground, typically in the PROW, and that is neither temporarily nor permanently attached to the ground, an adjacent building, or any other structure. All other signs require a City permit.

Obstruction: Temporary or permanent objects that might restrict pedestrian travel and access within the PROW. Obstructions include but are not limited to fire hydrants, lamp posts, trees, tree wells, parking meters, street furniture, trash receptacles, kiosks, utility pedestals, newspaper racks, free-standing signs, articles of display, outdoor dining area furniture, bus benches, and bus shelters.

Outdoor Dining Area: Any temporary dining area in the PROW or on private property that is not considered to be an "enclosed" space as defined by the City Land Development Code nor permitted by the City as a sidewalk cafe.

Outdoor Display Item: the particular product being displayed for public view and located outside a building. For this Program, a product being displayed for public view and located in the public right of way.

Path of Travel: A passageway for pedestrians and/or wheelchair users that provides access to and egress from a building, area, or location.

Public Right-of-Way: That portion of a property deeded to the City for streets, curbs, sidewalks, and other public improvements. For the purposes of this Program, the public right-of-way where streetscape enhancements may be located shall include only that portion between the curb and the property line, or where there is no curb, between the outer edge of the roadway and the property line.

Streetscape enhancements: see "enhancements".

Street furniture: items such as utility boxes or poles, bus benches or shelters, newsracks, mailboxes, street trees, lamp poles, or parking meters.

### **III. GENERAL REQUIREMENTS**

1. The City's rights with respect to the public right-of-way shall remain and continue in full force and effect and shall in no way be affected by the City's grant of permission to place the listed enhancements in the public right-of-way.
2. The Business Owner shall agree at all times to indemnify and hold the City free and harmless from and pay in full, any and all claims, demands, losses, damages, or expenses that the City may sustain or incur in any manner resulting from the construction, maintenance, state of use, repair, or presence of the enhancements installed herein under, including any loss, damage or expenses arising out of loss of or damage to property, and injury or death of persons, excepting any loss, damage or expense and claims for a loss, damage or expenses resulting in any manner from the negligent act or acts of the City, its contractors, officers, agents, or employees.
3. The Business Owner shall maintain a policy of liability insurance in the nature and amount satisfactory to the City Manager and the City Engineer in order to protect the City, the NPM, and the property owner from any potential claims, which may arise from the enhancements. The policy shall name the City, the NPM, the property owner, and their agents, officers, and employees as an additional insured. The City and the NPM shall be notified in writing by the insurer a minimum of ten (10) business days prior to any cancellation of policy. **Cancellation of a business' insurance policy immediately voids participation in the program.** A Business Owner needs to show, upon request by any City official or NPM employee, that he has insurance as required by the program. Each NPM shall establish and use a system of spot checking through the duration of the program.
4. The Business Owner shall remove or relocate, at Business Owner's own expense, any enhancement within three days after notice by the NPM, within three days after notice by the NPM under direction from the City, within two days after direct notice from the City by request of the NPM, or within two days after direct notice by the City (through a City official or by letter) when immediate response is not possible. If the Business Owner fails to remove or relocate the enhancement in the required time and manner, or if deemed necessary by the City, the City may cause such work to be done and charge the Business Owner for the cost of the work, at the sole discretion of the City, without further notice to the Business Owner. The City also has the authority to order that any enhancement be immediately removed or relocated to protect the life/health/ safety of the public.
5. The Business Owner shall maintain the PROW in a safe and sanitary condition at the sole cost, risk, and responsibility of the Business Owner.
6. Enhancements shall not be placed in the PROW during any repair or scheduled maintenance of a public utility within one hundred feet of the property lines of the participating business.
7. During public events, such as street fairs and parades, enhancements shall not be placed in the PROW without written approval, either general or specific, from the NPM.

8. Enhancements shall be placed so as not to block or obstruct vehicular visibility areas, including but not limited to the 25'-0" visibility triangle required at the intersection of any two streets (Illustration III-A) and the 10'-0" visibility area required at a driveway or alley intersecting a street (Illustration III-A).

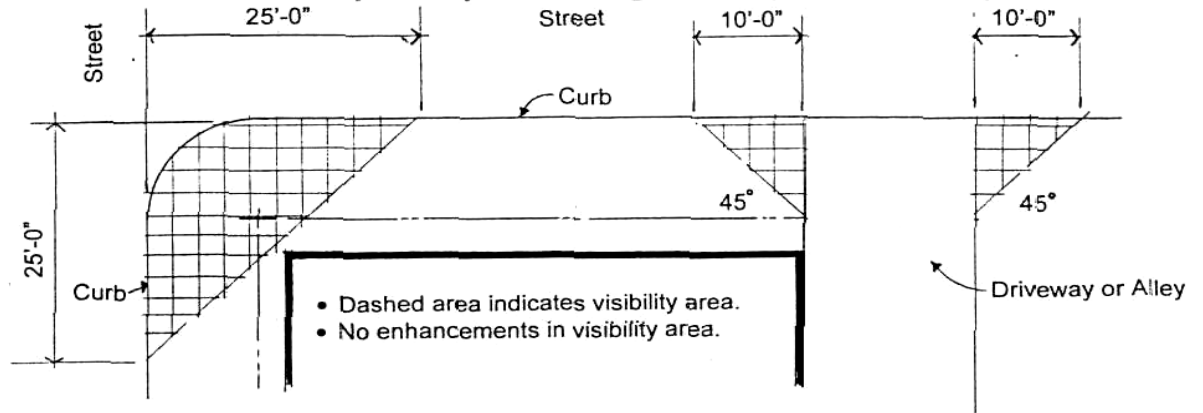

**Illustration III-A: Visibility Areas**

This illustration exhibits the specific requirements of the enhancement standards and is intended only as an aid.

9. Enhancements shall be placed so as to maintain a clear path of travel that has (a) a minimum width of 4'-0", (**Exceptions only in Little Italy with a 6'-0" minimum width and City Heights & North Park with a 5'-0" minimum width, and La Jolla with an 8' 0 minimum width, and Prospect St. from Hershel to Girard in La Jolla with a 6'0 minimum width**); (b) no more than thirty-degree changes of direction for travel along the PROW itself (**Exceptions only in City Heights and North Park with a required straight path of travel**); and (c) no travel onto private property except for access to and egress from a specific business, area, or location. (Illustration III-B).

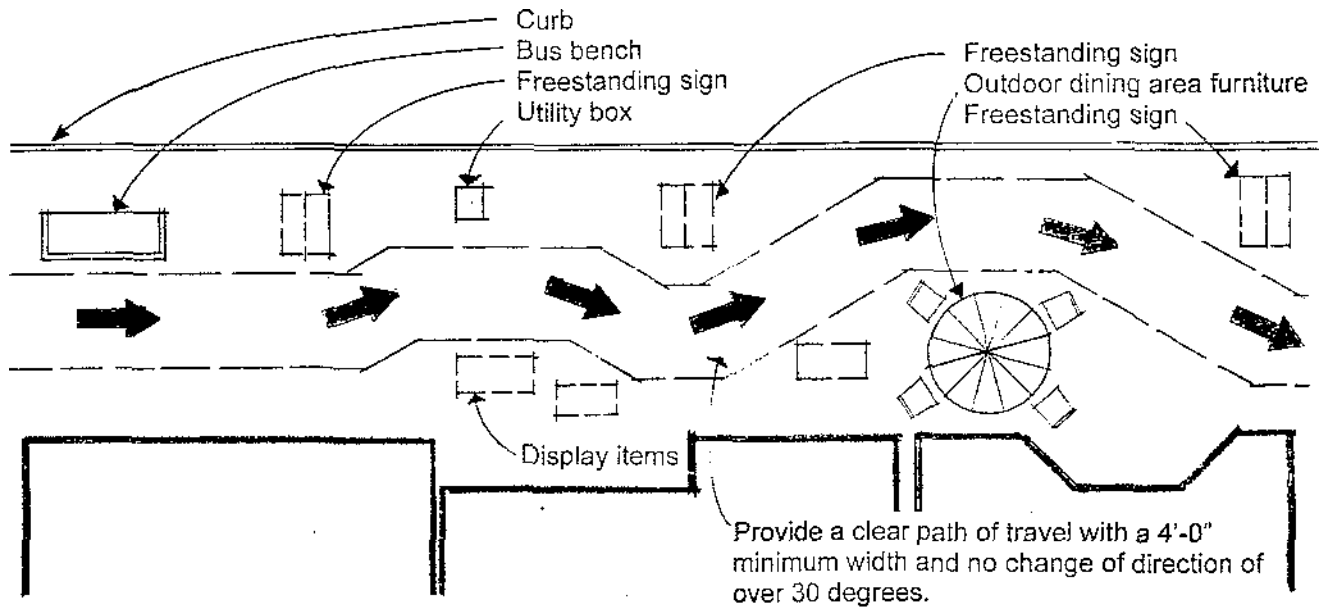

**Illustration III-B: Clear Path of Travel**

This illustration exhibits the specific requirements of the enhancement standards and is intended only as an aid.

10. Enhancements shall be placed no closer than two feet (2'-0") to the curb.
11. Enhancements shall be placed so as to not block or obstruct access to building entrances and exits (such as those areas required adjacent to a door for disabled access) and street furniture, including but not limited to, bus benches or shelters and public utility boxes and poles. (Illustration III-C)

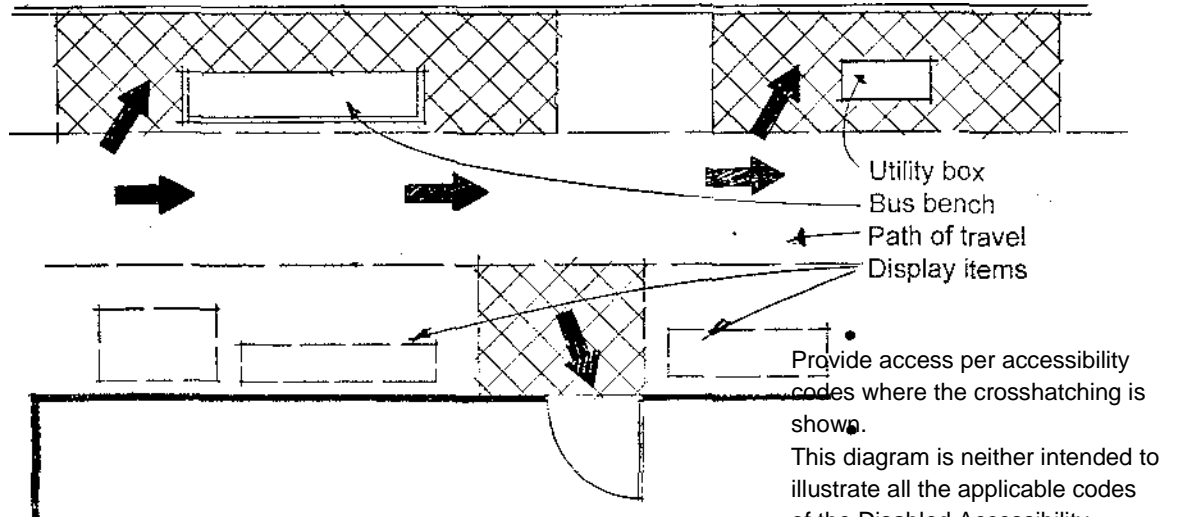

Illustration III-C: Accessibility

This illustration exhibits the specific requirements of the enhancement standards and is intended only as an aid.

This diagram is neither intended to illustrate all the applicable codes of the Disabled Accessibility Standards of the "C.B.C." (California Building Code) nor those of the "A.D.A." (American Disability Act).

12. Enhancements shall be placed in such a way so as not to substantially obstruct a business or restaurant's transparency (i.e. the views into a store or restaurant's interior and window displays). The business' transparency shall meet or exceed that required by the City Land Development Code for the business' zoning and occupancy type. (Illustration III-D)

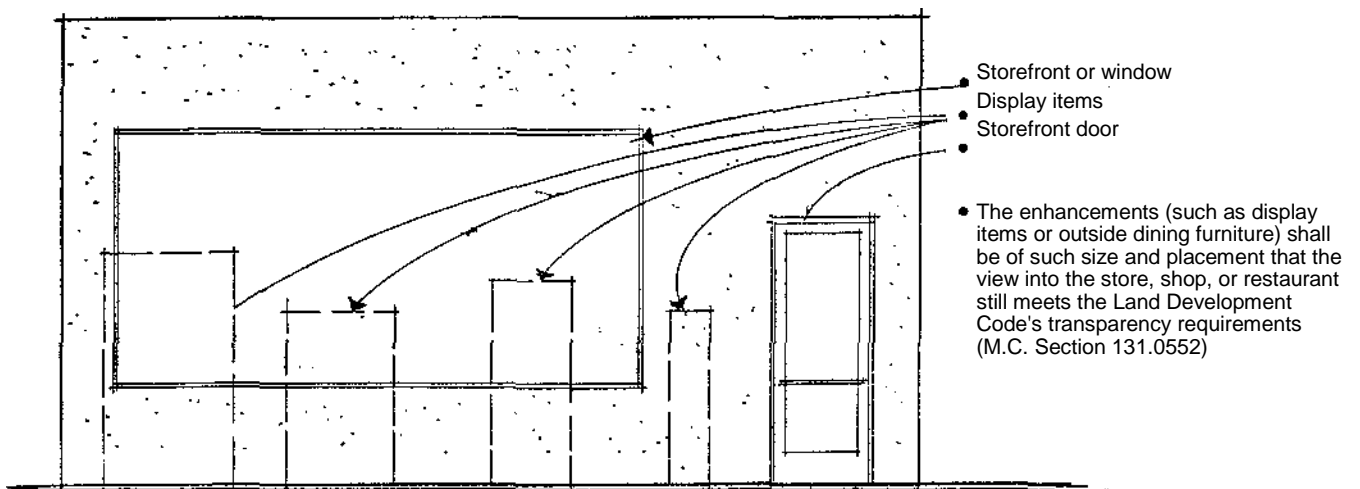
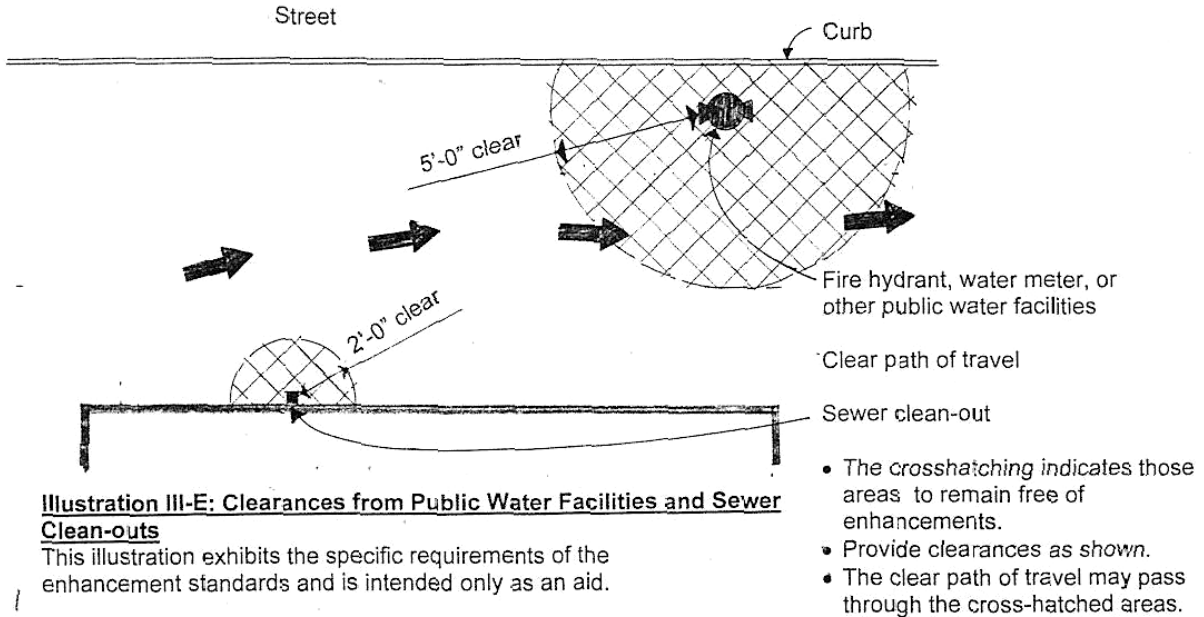

Illustration III-D: Window Transparency

This illustration exhibits the specific requirements of the enhancement standards and is intended only as an aid.



13. Enhancements shall be placed a minimum of five feet from any public water facilities including fire hydrants and meter boxes or assemblies. (Illustration III-E)
14. Enhancements shall be placed a minimum of two feet from any sewer lateral cleanout in the PROW. (Illustration III-E)



15. Enhancements (except flowerpots, flower planter boxes, and statuary) are permitted in the PROW only during business hours. Storage of these items shall be within the building during non-business hours.
16. Enhancements shall not be attached to public utility boxes and poles or other street furniture.
17. Business services (including those of cashiers or salespersons) and demonstrations shall not be provided in the PROW. Security personnel, business personnel managing an outdoor display area, and waiters or waitresses for outdoor dining areas are permitted in the PROW.
18. The PROW shall not be painted, resurfaced, or raised.

**NOTE:**

1. The scope of this Program does not include the installation of awnings, railings, and other permanent structures (except flower pots, flower boxes, and statuary) in the PROW.
2. The scope of this Program does not include any work performed or enhancements, whether temporary or permanent in nature, on private property. City ordinances may restrict or prohibit the use of enhancements in the private property immediately adjacent to the PROW that are permitted in the PROW under the scope of this Program.
3. It is the responsibility of the Business Owner to determine the location of the property line. (Note: Curb to property line dimensions may be obtained from the City Records Department, located on the second floor of the City Operations Building at 1222 Front Street, (619) 446-5200.)

#### **IV. FREESTANDING SIGN STANDARDS**

Any business which is not a Home Business and has a current business tax certificate issued by the City may have a freestanding sign complying with these standards.

**Note: Only those businesses fronting on the PROW (*Public Right-of-Way*) and located on the first floor may participate in this Program. Enhancements may be placed only in the PROW directly in front of the Business's storefront. Enhancements that do not comply with the General Requirements, Standards, and Conditions of this Program are not allowed.**

**A. Purpose (Illustration IV-A)**

Freestanding signs are allowed:

1. Subject to the restrictions in the General Requirements of this Program.
2. to identify the store, indicate that it is open, and its hours of business.
3. to show restaurant menus and daily specials
4. to advertise sales and special deals or services.



- Identify the business, indicate it is open, and list its hours of operation
- Show restaurant menus and daily specials
- Advertise sales, specials deals, and special services



**Illustration IV-A: Purpose**

This illustration exhibits the specific requirements of the enhancement standards and is intended only as an aid.

**B. Quantity**

1. Only one freestanding sign per business is allowed.
2. A maximum of two faces per sign is allowed.

**C. Placement**

A freestanding sign shall be:

1. located directly in front of the business it represents.
2. located in the PROW, but not within two feet of the curb, not in the clear path of travel and not in the clear areas adjacent to street furniture.
3. removed when weather conditions create potentially hazardous conditions.

**D. Size, Appearance, and Design**

1. The maximum footprint of a freestanding sign shall be 2'-0" x 3'-0". The sign height shall be between 3'-0" and 4'-0" (**Exception only in Little Italy where the freestanding height sign shall be 2'-0" and 4'-0"**). The sign shall be of A-frame style; pedestal signs or other types are not permitted. The sign boards shall continue to the ground for detection by those who are visually impaired. The bottom two inches of the sign shall have a strong contrast with the grade below for detection by those who are visually impaired. (Illustration IV-B)

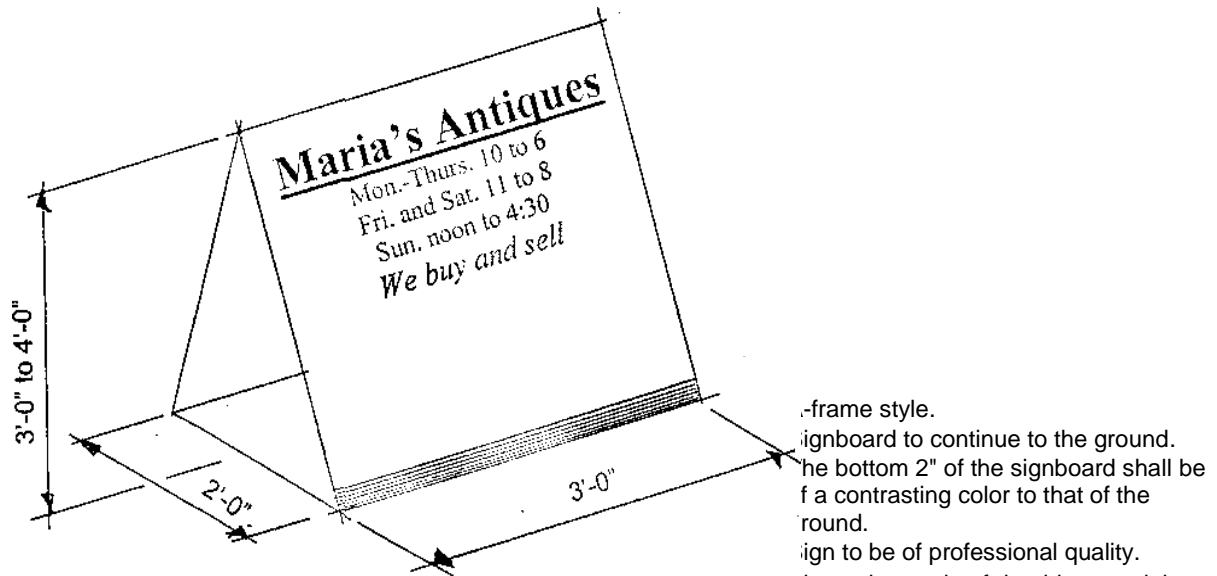

**Illustration IV-B:**  
**Size, Appearance, and Design**

This illustration exhibits the specific requirements of the enhancement standards and is intended only as an aid.

- Sign to be made of durable materials.
- No sharp edges or corners.
- No paper signs.
- No balloons, windsocks, pinwheels, or other wind-activated items.

2. The sign shall be designed to stand on its own.
3. The style of the sign's graphics shall be professional in quality and complement the business' permanent building sign(s), if any.
4. The sign shall be made of a durable material(s), such as medium density overlay plywood painted with enamel paint, stainless or other weatherable steel, laminate plastic, slate chalkboard, or marker board. A natural wood 1" x 2" frame is strongly encouraged. No glass, breakable materials, or attached illumination shall be allowed. Every sign and all parts, portions, and materials shall be manufactured, assembled, and erected in compliance with all applicable federal, state, and local regulations.
5. Paper signs, wind-activated items (such as balloons, windsocks, and pinwheels), and non-rigid changeable areas shall not be used as or attached to a sign.
6. The sign shall have no sharp edges or corners. All surfaces shall be smooth and be free of protruding tacks, nails and wires. All parts, portions, and materials of a sign shall be kept in good repair. The display surface shall be kept clean, neatly

painted, and free from rust, corrosion, and graffiti. Any cracked or broken surfaces, missing sign copy, or other poorly maintained or damaged portion of a sign shall be repaired, replaced or removed.

7. No sign copy referring to off-premise locations shall be permitted. (Example: "Visit our main store in Clairemont.").
8. No live advertising (such as character actors or employees holding a sign) shall be permitted.
9. **In La Jolla, A frame signs are not permitted. However, The NPM may have a sponsored sign program in the right of way (one or two per block) may be permitted**

## **V. OUTDOOR DISPLAY STANDARDS**

**Note: Only those businesses fronting on the PROW (Public Right-of-Way) and located on the first floor may participate in this Program. Enhancements may be placed only in the PROW directly in front of the Business's storefront. Enhancements that do not comply with the General Requirements, Standards, and Conditions of this Program are not allowed.**

**A. Purpose:** The purpose of outdoor display areas is to attract customers into retail, repair, or service businesses, not to sell the item(s) on display. Price tags/advertisements are not permitted.

### **B. Allowable Display Areas (Illustration V-A.)**

1. The permitted display items shall be placed in the PROW for a distance no more than 4'- 0" from the property line. (Note: the street wall of the building may or may not be located at the property line. It is the responsibility of the Owner to determine the location of the property line.) The actual allowable depth of the exhibit area from property line towards the curb may be less due to other restrictions. (See Section III: General Requirements.)
2. The display areas shall be limited to the length of the business' storefront.

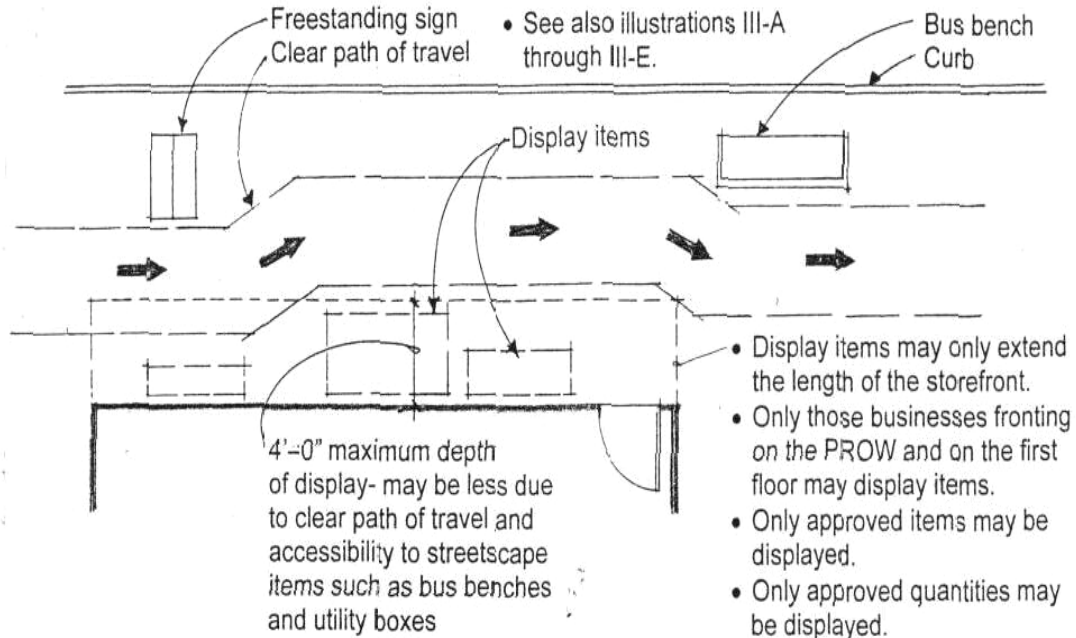

**Illustration V-A: Location of Display Items in the PROW**

This illustration exhibits the specific requirements of the enhancement standards and is intended only as an aid.

**C. Permissible Merchandise**

The following items may be displayed in the PROW, provided the Business Owner abides with this section of the Program with regards to allowable display areas and items, display requirements, and maximum allowed quantities. The merchandise shall be free of graffiti and constitute no hazard to pedestrian traffic.

1. Furniture: patio furniture and wooden and metal furniture (excluding mattresses and sofas).
2. Books and magazines
3. Produce, baked goods, and food in glass containers
4. Cut or live flowers and plants
5. Clothing and accessories.
6. Hand crafted products and goods.
7. Art work, including paintings, photography, sculpture, frames, and pottery, displayed by retail, supply, or service businesses.
8. Sports equipment.
9. Bicycles.
10. Musical instruments.
11. Leather goods.
12. Luggage.
13. Rugs.
14. Pet accessories.
15. Other merchandise similar in character, type, or nature to the merchandise listed above with written approval from the NPM having jurisdiction.

**(Exception only in La Jolla where #3, #4, #6, #7 will be the only items permitted)**

#### **D. Merchandise not permitted:**

Any merchandise not falling within the approved categories shall not be displayed outdoors, including, but not limited to, the following:

1. Alcoholic beverages.
2. Tobacco, cigarettes, and smoking accessories.
3. Upholstered items with a cumulative height, width and depth of nine feet or more.
4. Shoes, except those displayed on mannequins or props.
5. Clothing hung on racks.
6. Vending and dispensing equipment.
7. Appliances.
8. Canned or prepackaged foods.
9. Adult-oriented material.
10. Auto-related merchandise.
11. Mattresses.
12. Major appliances
13. Compact discs, videotapes, cassette tapes, digital video discs, and similar items.
14. Computers, business machines, and home electronics.
15. Cameras and photographic equipment.
16. Live animals.
17. Pet food.
18. Pawned items.
19. Weapons, including, but not limited to, knives, fencing swords, and antique pistols.
20. Home cleaning products.
21. Personal care items
22. Other merchandise similar in character, type, or nature to that listed above.

#### **E. Maximum Quantities**

Businesses may display one or two of the following five types of merchandise:

1. Furniture, limited to one item for every five linear feet of storefront. (Example: a store with a gross storefront length of 25 feet may display up to a maximum of five items.)
2. Book and magazine racks, limited to one rack per every storefront length of 25 feet or portion thereof.
3. Hand-crafted products and goods, artwork, and/or pottery, limited to two items for every five feet of storefront. (Example: a store with 25 feet of storefront may display up to a maximum of ten items.)
4. Food products, limited to one linear foot of display space for every five feet of storefront. (Example: a store with 25 feet of storefront may display food products along a maximum of five linear feet.)
5. Dress apparel [clothing, accessories, and shoes (as allowed)], limited to six pieces, (Note: if seven to twelve articles of apparel, whether clothing, accessories, or shoes, are displayed, then no other type or quantity of merchandise may be displayed.) (Example: a store with 25 feet of storefront may display six pieces of apparel and a rack of books or display twelve pieces of apparel.)

## **F. Display Requirements**

1. All items publicly displayed shall be in good condition, not require repair, and not be wrapped in plastic or other wrapping materials.
2. Items shall be displayed appropriately (preferably on three-dimensional props) that coordinate with the store facade. Cardboard boxes and folding tables are not permitted as display racks.
3. Clothing shall be hung only on mannequins or props, except that clothing may be displayed on hangers on the door(s) of the business.
4. Books and magazines shall be displayed on racks 3'-0" to 4'-0" in height. Books shall be displayed to allow the title and author of each book to be seen. Each rack shall be no more than 6'-0" in length. (Illustration V-B), Racks shall be in good condition and not require repair.

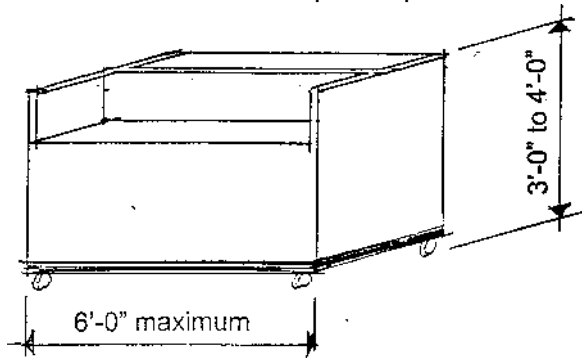

- Bookcases and magazine racks must extend to within two inches of ground and have a two inch wide stripe of color that contrasts with the ground.

### **Illustration V-B: Book and Magazine Racks**

This illustration exhibits the specific requirements of the enhancement standards and is intended only as an aid.

5. All items and displays shall be safe and stable with no risk of overturning due to wind or contact. Props and items of display shall not project into the clear path of travel; corners shall be rounded. Businesses shall remove displays when weather conditions create a potentially hazardous condition.
6. All items (such as racks, mannequins, props, furniture and other display items) must extend to within 2 inches of the ground and have a two-inch wide stripe at all bottom edges or in some other manner be physically and visually detectable in an easy manner by the visually impaired.

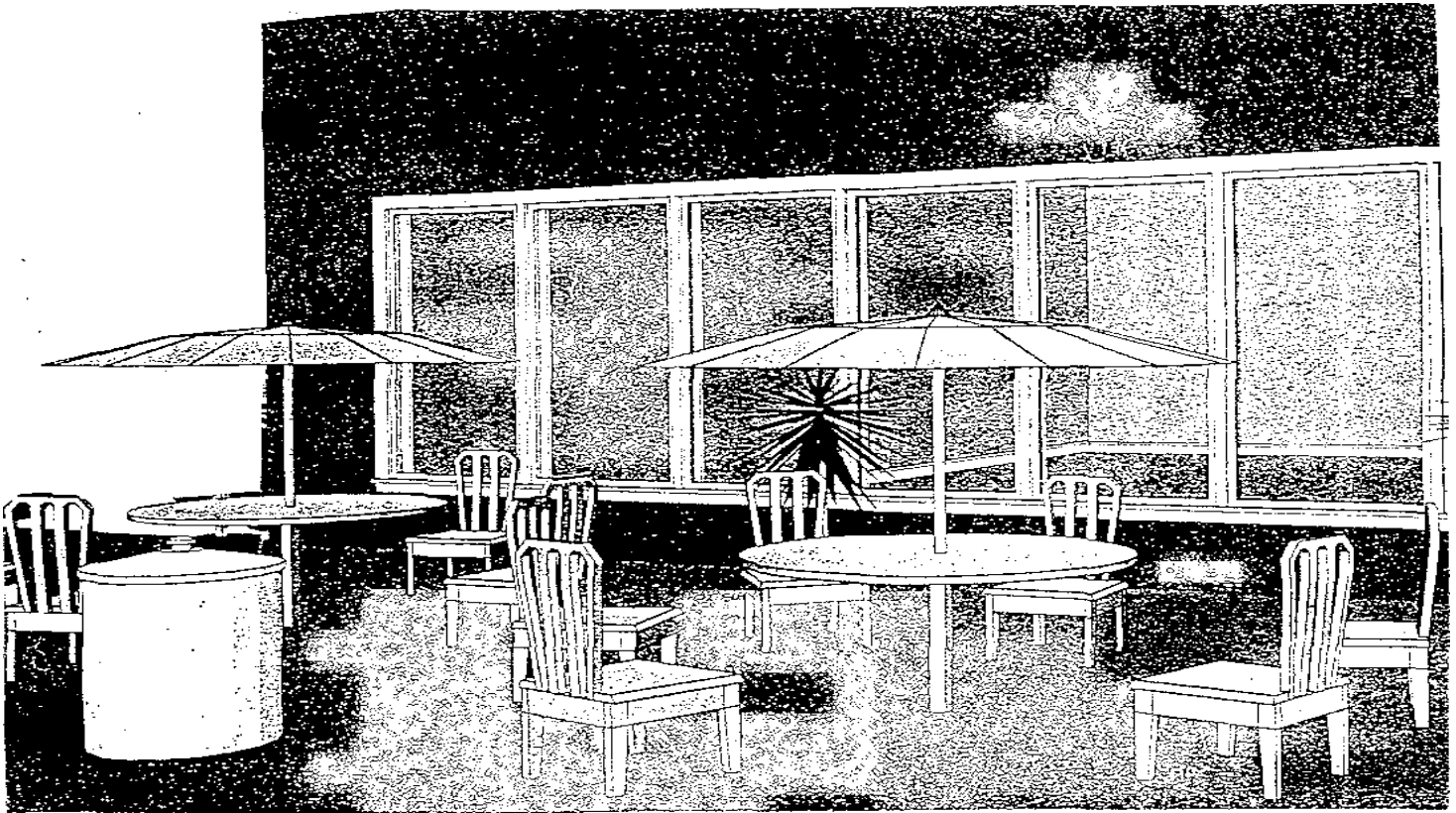

## **VI. OUTDOOR DINING AREA STANDARDS**

### **Illustration VI-A**

**Note: Only those businesses fronting on the PROW (Public Right-of-Way) and located on the first floor may participate in this Program. Enhancements may be placed only in the PROW directly in front of the *Business Owner's* storefront. Enhancements that do not comply with the General Requirements, Standards, and Conditions of this Program are not allowed.**

1. Businesses licensed to serve food and/or beverages are permitted to have an outdoor dining area that complies with the standards of this program. **(Exception only in La Jolla where not outdoor dining is permitted in Zone 5 and Zone 6 of the La Jolla Planned District Ordinance (PDO))**
2. The sale of **alcoholic beverages** in an outdoor dining area requires a City of San Diego **sidewalk café permit** and licensing by the Department of Alcoholic Beverage Control. **Alcohol cannot be sold or consumed in outdoor dining areas permitted under this program.**
3. **Coastal Zone:** A Coastal Development Permit must be obtained through the City where the total outdoor dining area will exceed 200 square feet, and the site is located within the Beach Impact Area of the Parking Impact Overlay Zone.
4. The hours of operation of the outdoor eating area shall not exceed those of the primary use.
5. An outdoor dining area may include the use of all the area in the PROW adjacent to the business **except** that area required for the **clear path of travel** or clear area adjacent to street furniture, such as bus benches or utility boxes and that area of the PROW within two feet of the curb. Exception: the area within two feet of the curb may be used if the parking is head-on. (Illustration VI-B). (See also illustrations III-A through III-E.)



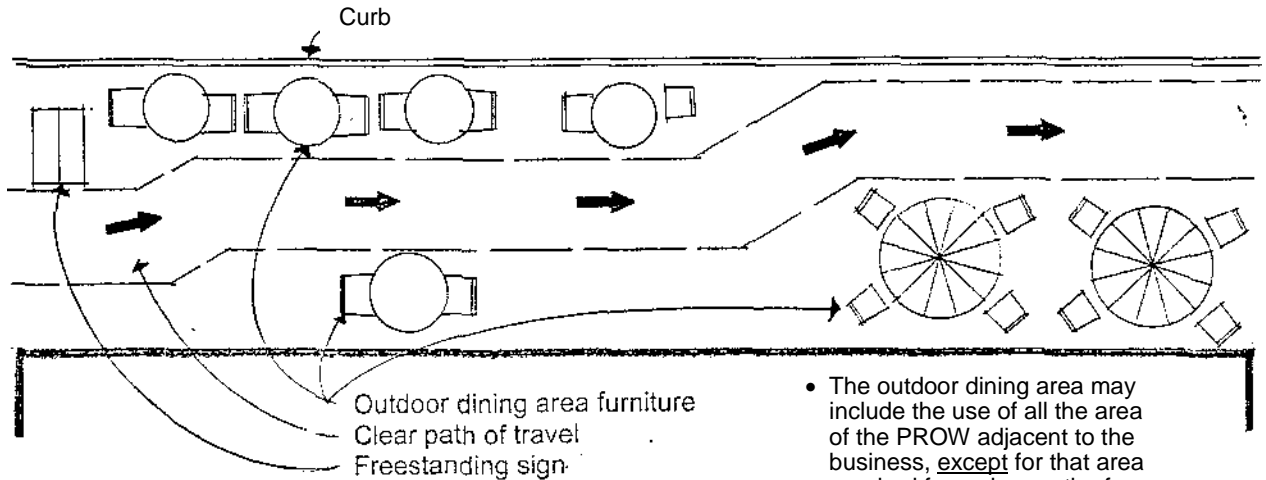

**Illustration VI-B- Location of Outdoor Dining Area in the Public Right of Way**

This illustration exhibits the specific requirements of the enhancement standards and is intended only as an aid.

- The outdoor dining area may include the use of all the area of the PROW adjacent to the business, except for that area required for a clear path of travel, including path of travel to street furniture such as bus stops and utility boxes as well as the entrance to the restaurant.
- See also illustrations III-A through III-E.

6. Tables and chairs shall be metal, wood, durable plastic, or other approved material, and must be in good condition and not require repair. Umbrellas must be in good condition, be fire-treated, and not require repair.
7. Permanent lighting complying with City and accessibility standards and installed with electrical permits may be provided for the PROW. The lighting shall be attached to the building.

**VII. PERMIT CONDITIONS**

The person(s), business company, or corporation applying for participation in the Program shall be hereby named as the "applicant".

1. This application is subject to written approval by the NPM (Non-profit Management having jurisdiction).
2. Approval by the NPM allows for temporary use of the public right-of-way as set forth in the Public Right-of-Way Enhancement Program.
3. Displays without approval of an application are not permitted.
4. The applicant(s) shall provide evidence of having one million dollars of liability insurance naming the City of San Diego, the NPM, the property owner, and their agents, officers, and employees as additional insured. The applicant(s) shall maintain the policy continuously. The City of San Diego and the NPM shall be given ten day notice prior to the cancellation of the policy. **Cancellation of a Business Owner's insurance policy immediately voids participation in the program.** A Business Owner needs to show upon request by any City official or NPM employee that he has insurance as required by the program. Each NPM shall establish and use a system of spot checking through the duration of the Program.
5. The applicant shall provide two copies of a scale drawing of the proposed enhancement/ use. The drawing shall be no smaller than 8.5" x11" nor larger than 11" x 17". The drawing shall indicate the curb and property lines, all existing and proposed obstructions (traffic signs, traffic lights, street lights, bus benches, fire hydrants, etc.), and location of proposed freestanding sign, exhibit areas, outdoor dining area furniture, planter boxes, and statuary. Applicants for any business located at a corner property or on a property that has a depth

that runs from street to street shall provide information for both street frontages. Note: applicant shall submit changes to plans for approval by the NPM.

6. The applicant shall provide two copies of a photograph or photographs of the area of the proposed enhancement. The photograph(s) shall include the entire area of the enhancement as well as the adjacent property to each side. Applicants for any business located at a corner property or a street-to-street property shall provide photographs for both street frontages.
7. The applicant shall attend a free training demonstration provided by the NPM prior to displaying a free-standing sign or outdoor displays or opening an outdoor dining area.
8. The applicant shall provide the NPM with a curb-to-property line card obtained from the City Records Department (second floor of 1222 First Avenue, (619) 446-5200).
9. This application is not transferable.

### **VIII. ENFORCEMENT AND DUE PROCESS**

1. Streetscape enhancements that do not comply with the provisions of this Program are not allowed.
2. Initial enforcement shall be conducted by the NPM having jurisdiction. The NPM shall keep records of contact with applicants and disposition of issues shall be reported to the community's Planning Committee in a timely fashion. This information is also to be provided to the Neighborhood Code Compliance Department on a quarterly basis and as otherwise requested by the NCCD.
3. The Business Owner shall remove or relocate, at Business Owner's own expense, any enhancement within three days after notice by the NPM, within three days after notice by the NPM under direction from the City, within two days after direct notice from the City by request of the NPM, or within two days after direct notice by the City (through a City official or by letter) when immediate response is not possible. If the Business Owner fails to remove or relocate the enhancement in the required time and manner, or if deemed necessary by the City, the City may cause such work to be done and charge the Business Owner for the cost of the work, at the sole discretion of the City, without further notice to the Business Owner. The City also has the authority to order that any enhancement be immediately removed or relocated to protect the life/health/safety of the public.
4. When a NPM's efforts to gain voluntary compliance fail and all deadlines have expired, a written notice will be given to the Business Owner that his participation in the Program has been canceled. Notice of this will be forwarded to the NCCD (Neighborhood Code Compliance Department) for investigation and action. At that time, copies of NPM records of all attempts at voluntary compliance will be forwarded to the NCCD. The violator may then be subject to civil penalties, abatement, and/or judicial remedies.

**WINDOW STICKER**

**PUBLIC RIGHT-OF-WAY ENHANCEMENT PROGRAM**

\_\_\_\_\_, a business owned by \_\_\_\_\_ and located at \_\_\_\_\_ is a participant in the Public Right-of-Way Enhancement Program provided that their freestanding sign, outdoor display items, and/or outdoor café comply with the General Requirements, Standards, and Conditions of the Program. **For complaints or further information,** contact \_\_\_\_\_, director of the \_\_\_\_\_ Non-profit Management Corporation, an agency of the \_\_\_\_\_ Business Improvement District, located at \_\_\_\_\_, San Diego, ( ) \_\_\_\_\_, fax ( ) \_\_\_\_\_ and e-mail address of \_\_\_\_\_.

**Application Form**  
**PUBLIC RIGHT-OF-WAY ENHANCEMENT PROGRAM**

The person(s), business company, or corporation applying for participation of this Program shall be hereby named as the "applicant".

**PERMIT CONDITIONS**

1. **Only those businesses fronting on the Public Right-of-Way and located on the first floor may participate in this Program.**
2. **Enhancements may be placed only in the Public Right-of-Way directly in front of the Business' storefront.**
3. **Enhancements that do not comply with the General Requirements, Standards, and Conditions of this Program are not allowed.**
4. This application is subject to written approval by the NPM (Non-profit Management) having jurisdiction).
5. Approval by the NPM allows for temporary use of the public right-of-way as set forth in the General Requirements, Standards, and Conditions of this Program.
6. Displays without approval of an application are not allowed.
7. The applicant(s) shall provide evidence of having one million dollars of liability insurance naming the City of San Diego, the NPM, the property owner, and their agents, officers, and employees as additional insured. The applicant(s) shall maintain the policy continuously. The City of San Diego and the NPM shall be given ten day notice prior to the cancellation of the policy. **Cancellation of a Business Owner's insurance policy immediately voids participation in the Program.** A Business Owner shall show upon request by any City official or NPM employee that he has insurance as required by the Program. Each NPM shall establish and use a system of spot checking through the duration of the Program.
8. The applicant shall provide two copies of a scaled drawing of the proposed enhancement/ use. The drawing shall be no smaller than 8.5" x11" nor larger than 11" x 17". The drawing shall indicate the curb and property lines, all existing and proposed obstructions (traffic signs, traffic tights, street lights, bus benches, fire hydrants, etc.), and location of proposed freestanding sign, exhibit areas, outdoor area furniture, planter boxes, and statuary. Applicants for any business located at a comer property or a street-to-street property shall provide information of both street frontages.
9. The applicant shall provide two copies of a photograph or photographs of the area of the proposed enhancement. The photograph(s) shall include the entire area of the enhancement as well as the adjacent property to each side. Applicants for any business located at a comer property or a street-to-street property shall provide photographs for both street frontages.
10. The applicant shall attend a free training demonstration provided by the NPM prior to displaying a free-standing sign or outdoor displays or opening an outdoor dining area.
11. The applicant shall provide the NPM with a curb-to-property line card obtained f the City Records Department (second floor of 1222 First Avenue, (619) 446-520(
12. This application- is not transferable.

**Application Form - continued**  
**PUBLIC RIGHT-OF-WAY ENHANCEMENT PROGRAM**

**ENFORCEMENT AND DUE PROCESS**

1. Streetscape enhancements that do not comply with the provisions of this Program are not permitted.
2. Initial enforcement shall be conducted by the NPM having jurisdiction. The NPM shall keep records of contact and shall report their disposition to the community's Planning Committee in a timely fashion.
3. The Business Owner shall remove or relocate, at Business Owner's own expense, any enhancement within three days after notice by the NPM, within three days after notice by the NPM under direction from the City, within two days after direct notice from the City by request of the NPM, or within two days after direct notice by the City (through a City official or by letter) when immediate response is not possible. If the Business Owner fails to remove or relocate the enhancement in the required time and manner, or if deemed necessary by the City, the City may cause such work to be done and charge the Business Owner for the cost of the work, at the sole discretion of the City, without further notice to the Business Owner. The City also has the authority to order that any enhancement be Immediately removed or relocated to protect the life/health/safety of the public.
4. When a NPM's efforts to gain voluntary compliance fail and all deadlines have expired, a written notice will be given to the Business Owner that his participation in the Program has been canceled. Notice of this will be forwarded to the NCCD (Neighborhood Code Compliance Department) for investigation and action. At that time, copies of NPM records of all attempts at voluntary compliance will be forwarded to the NCCD. The violator may then be subject to civil penalties, abatement, and/or judicial remedies.

**GENERAL INFORMATION**

**Date:** \_\_\_\_\_

1. Business Name \_\_\_\_\_

2. Business Address \_\_\_\_\_

\_\_\_\_\_  
Number Street Suite No. Zip Code

3. Owner's Name(s) \_\_\_\_\_

Printed Name

Title

\_\_\_\_\_  
Printed Name

Title

4. Business Phone No. \_\_\_\_\_ Fax No. \_\_\_\_\_

E-mail address: \_\_\_\_\_

5. Property Owner's Name \_\_\_\_\_

6. Property Owner's Phone Number \_\_\_\_\_

7. NPM (Non-profit Management) \_\_\_\_\_

8. NPM Executive Director \_\_\_\_\_

9. NPM Address \_\_\_\_\_

10. NPM Phone Number \_\_\_\_\_

**SPECIFICATIONS OF ENHANCEMENT TYPE**

Circle/check any or all of the following for which this application is submitted.

\_\_\_ Freestanding Sign    \_\_\_ Outdoor Display    \_\_\_ Outdoor Dining Area

- A copy of this application and its drawings shall be kept on file at NPM office for public viewing. A notice of this application and plans shall be kept on file at the business site. The notice at the site shall be posted in a window for public viewing.
- Changes to the plans shall be submitted to the NPM for approval.
- Signature(s) below indicate that the applicant has read the reverse side of this application form and the General Requirements, Standards, and Conditions of this Program and agrees to comply with them. "Enforcement and Due Process" is hereby made part of this application.

\_\_\_\_\_  
Applicant's Printed Name                      Applicant's Signature                      Date                      Date attended seminar

\_\_\_\_\_  
Applicant's Printed Name                      Applicant's Signature                      Date                      Date attended seminar

\_\_\_\_\_  
NPM Director's Signature                      Date